



LEGO MY SYSTEM!



Welcome!

A SPACE TO THINK DIFFERENTLY AND MAKE IDEAS HAPPEN

Our Aspirations

- **Connect** and **strengthen** relationships in this network
- Provide a mix of **theory** and **learning by doing**
- Spark spin-off **work** and **collaborations** from new connections
- Have **fun** learning together!



Coming Soon

☐ **Foresight Walk & Summer Social**

*Mid-August 2018 @ City Centre
(late afternoon-early evening)*

☐ **Fall Series**

We want your input!

Want to lead a session?

Want to write a Medium piece?



Objectives Today

- Understand a bit more about LEGO Serious Play with just enough understanding to experiment with applying in your own contexts



Why “Serious Play”?

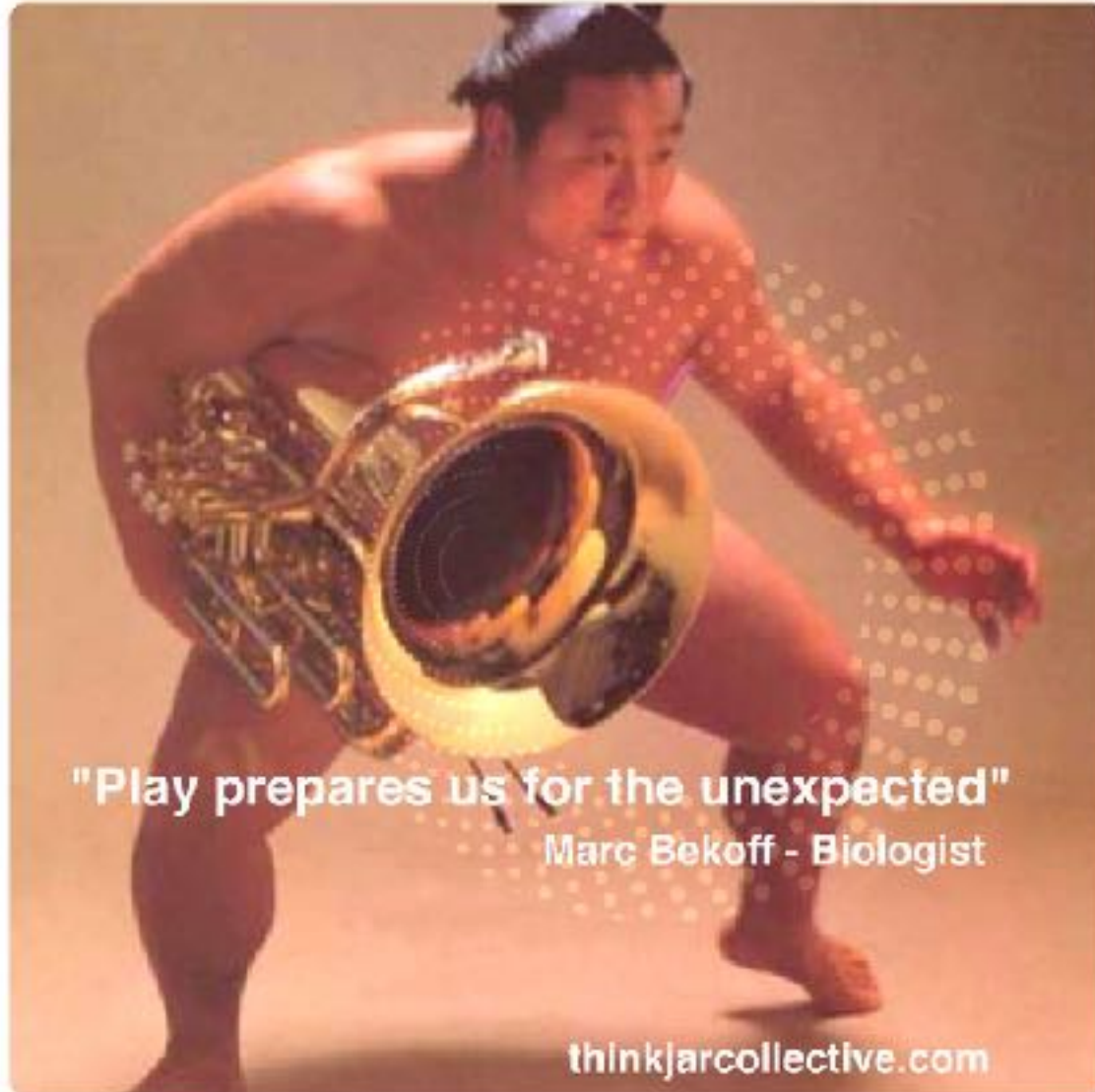

"Play prepares us for the unexpected"

Marc Bekoff - Biologist

thinkjarcollective.com



“
Innovation is a
mixture
of the old and the new
with a dash of
surprise

“
Al Etmanski

Unexpected

How good are our minds at playing with ideas fluidly?

“It is the mark of wisdom to be able to entertain a thought without accepting it”

Aristotle

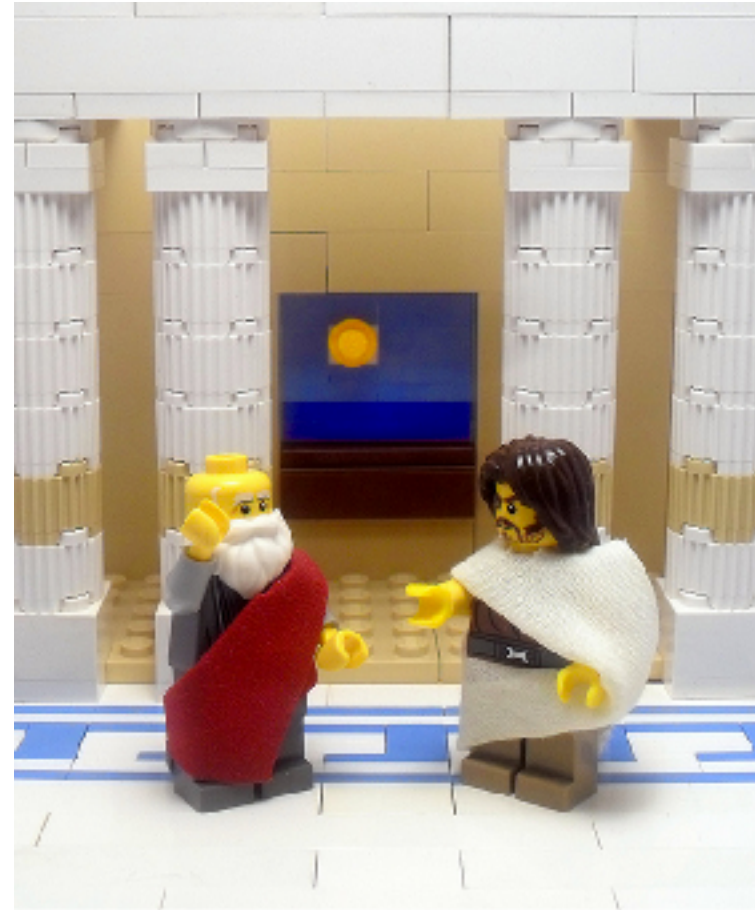

Take it from Gerty

“I think what helps me keep creative is seeking out interactions with passionate, creative people...

*Hard to put into words what happens...but kinda like, **weird, humourous, spontaneous interactions can JAR me out of habitual patterns of thinking”***

Gertrude- Research participant



Play



Trust



**Better
Problem
Solving**

Authentic expressions
Be yourself
Playfulness
Poking fun at yourself
Playing with ideas



Openness
Empathy
Receptivity
to
new
possibilities



Better collaboration
Better
problem solving

So, what the heck is LEGO® SERIOUS PLAY® ?

Tool for...

- Strategic Planning
- Community Engagement
- Relationship building with teams
- Product development
- Story telling
- Sense making of complex issues

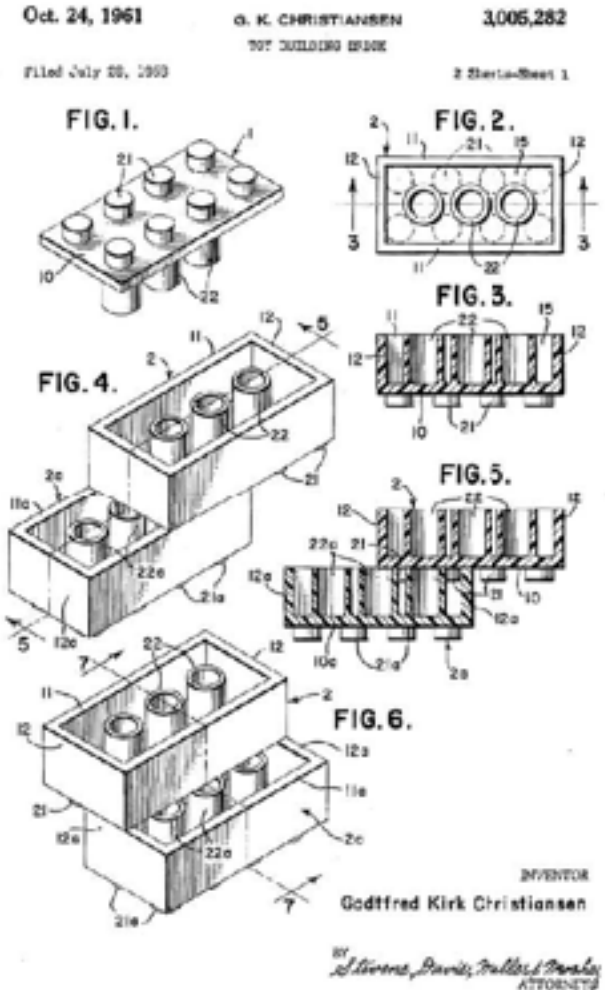

Models of ideas



Think through your hands



Community Building



Knowledge Generation & Story Telling



Deep Dive Strategic Planning



5 BUILDING A SYSTEM

- Create connections:
- 🧱 Points of connection
 - 🧱 Nature of connection
 - 🧱 Response to change



4 Stages

1. Question posed



2. We build



3. Share the story



4. Reflect

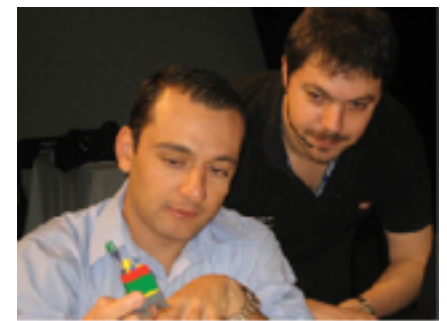

Underlying Principles Lego Serious Play method remixed in the 90s

- **Constructivism** - Knowledge is not acquired but constructed through experiences- Piaget
- **Constructionism** - When people construct things out in the world, they simultaneously construct theories and knowledge in their minds - Papert

When we think through our fingers, we unleash creativity and modes of thought that as adults we mostly have lost.

- **Systems Thinking** - To shift larger systems first have to understand our own mental models and influence on larger systems

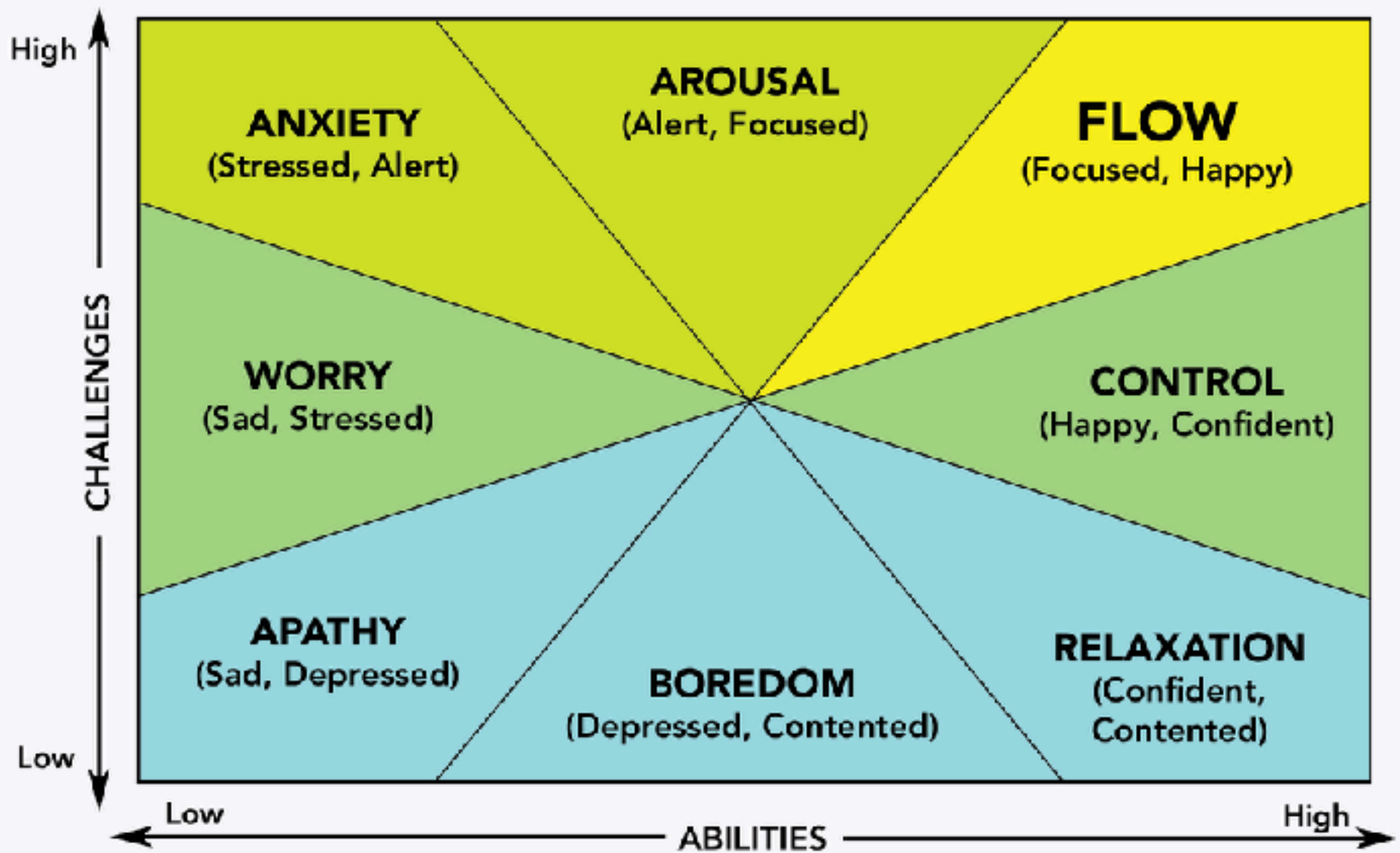

Mihály Csíkszentmihályi's model of flow as related to challenge and ability.

Lego Serious Play early research found 4 purposes of adult play

- 1. Social Bonding**
- 2. Emotional Expression**
- 3. Cognitive development**
- 4. Constructive Competition**



LEGO

SERIOUS PLAY



BUILDING

METAPHORS

ONE

BRICK

AT A

TIME

KERI FAIL

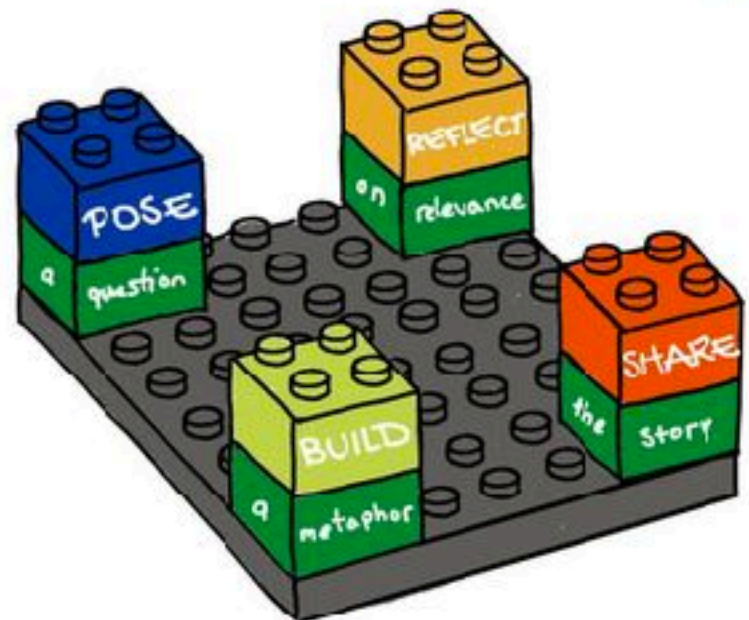

Most of what you know is buried in your subconscious.

Tactile activities fire brain cells. TRUST YOUR FINGERS!



People love hearing and telling stories

- Be Open
- Be Active
- Experiment
- Seek Out New Experiences

LEGO® SERIOUS PLAY®

Rules of Engagement



- Be open minded
- No electronics
- Be on time for transitions
- Have hard fun
- Tell your story
- Listen and Reflect
- Trust the Process
- Question the model not the person's experience



Key things to remember

There isn't a wrong way to build!

It's not about perfect lego models, it's about stories

Stay on track with the time constraints



The most complicated part of today!

Send one person
per table
to grab enough
Lego kits
for the number of
people at your table



First always start with Lego Serious Play skill building

People need two things for LSP

1. Know how the bricks click together and work
2. Know that our brains can make connections, metaphors, analogies and stories from the bricks



2 mins

**Find the black
baseplate**

Put together the little
blue figure with a
yellow face

**Build a tower
on the black base plate
and add the figure**

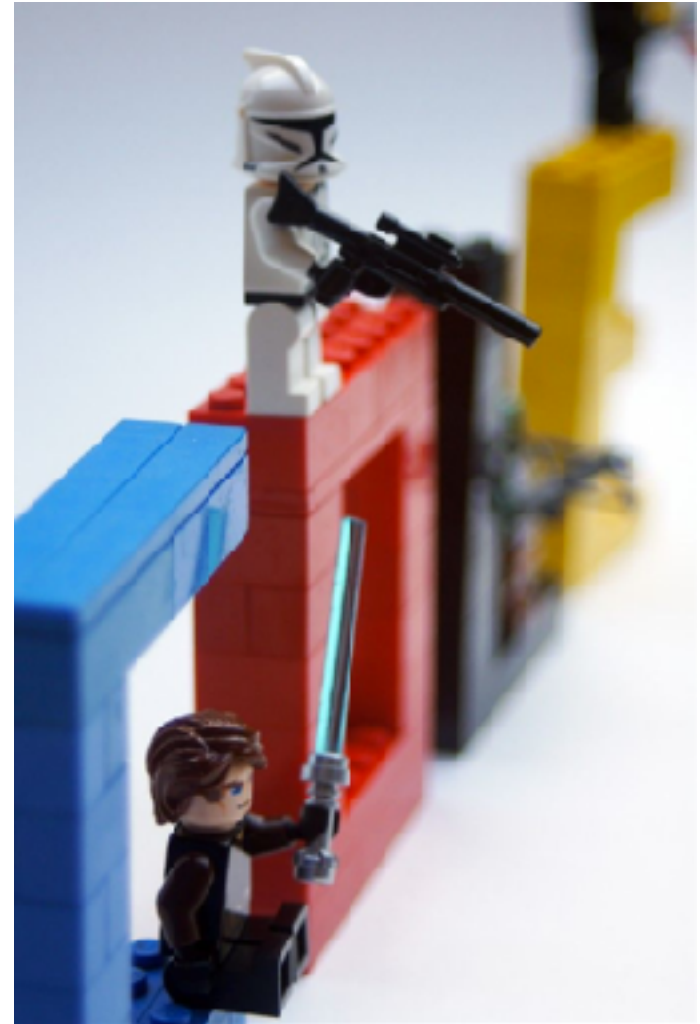

5 mins

Take turns at your
table to each
describe
how your model is
either like
**marriage/
partnership**
or
like **government**

Just pick one
topic



Your Personal Complexity Problem Solving Super Power!

4 mins

On the black base plate

Build a portable model of your personal complexity problem solving super power

Any kind of strength or a special design or systems strength you know that helps when tackling complex challenges



*Has to be portable!
Don't break this one!*



Okay 2nd most complicated part of today!

1. Put your name on your lego bag in sharpie
2. Put the left over pieces from your build in the lego bag
3. Keep your model you just built intact and keep for a while



What the heck is a system?

Simple explanation: A system is a set of interacting parts that form a whole. It is both **individual parts** and **how the parts interact**.

Systems thinking helps us see deeper assumptions, and patterns. When we collectively explore assumptions and patterns in a system we can generate insights, and leverage points for change

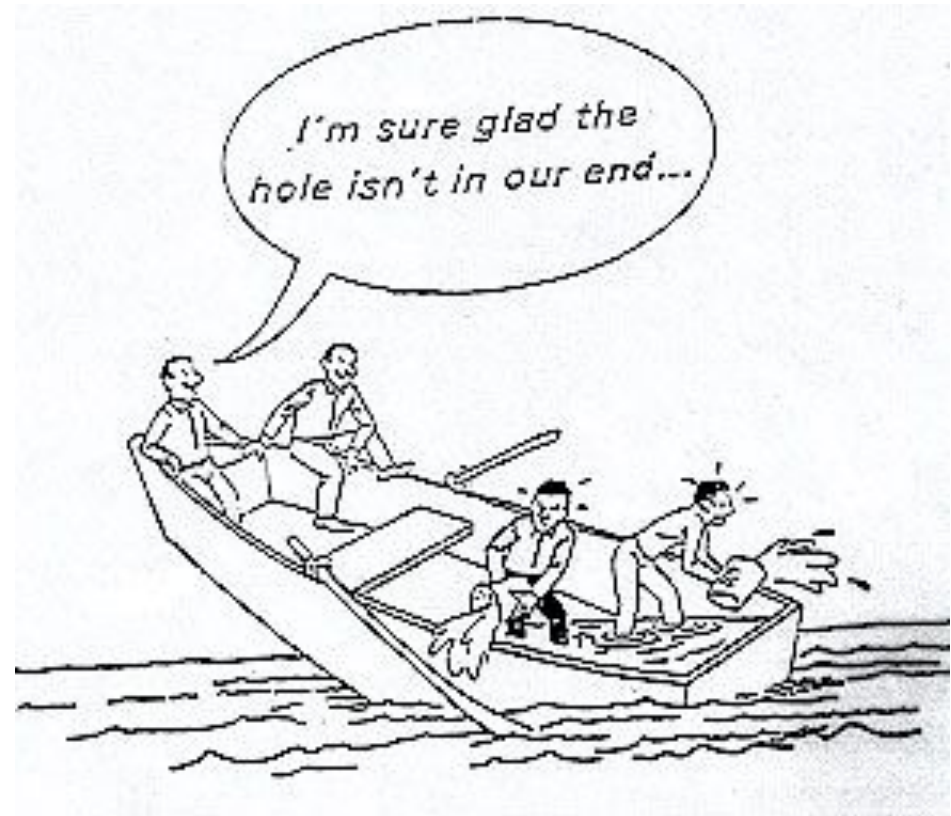

General typology of problems/challenges



Simple

Complicated

Complex



LEGO LOCAL

general public

other media

Pe
7

TREND

Build in the agents and forces

Agents can be factors that influence the system or problem...

- They can be obvious or subtle
- They can be **physical, political, people, environmental, big or small**

Place the agents in relationship to your problem landscape features

- Discuss together as you build and place them
- Place the agents **where agents influence the system or parts of the problem**
-



Label the agents!

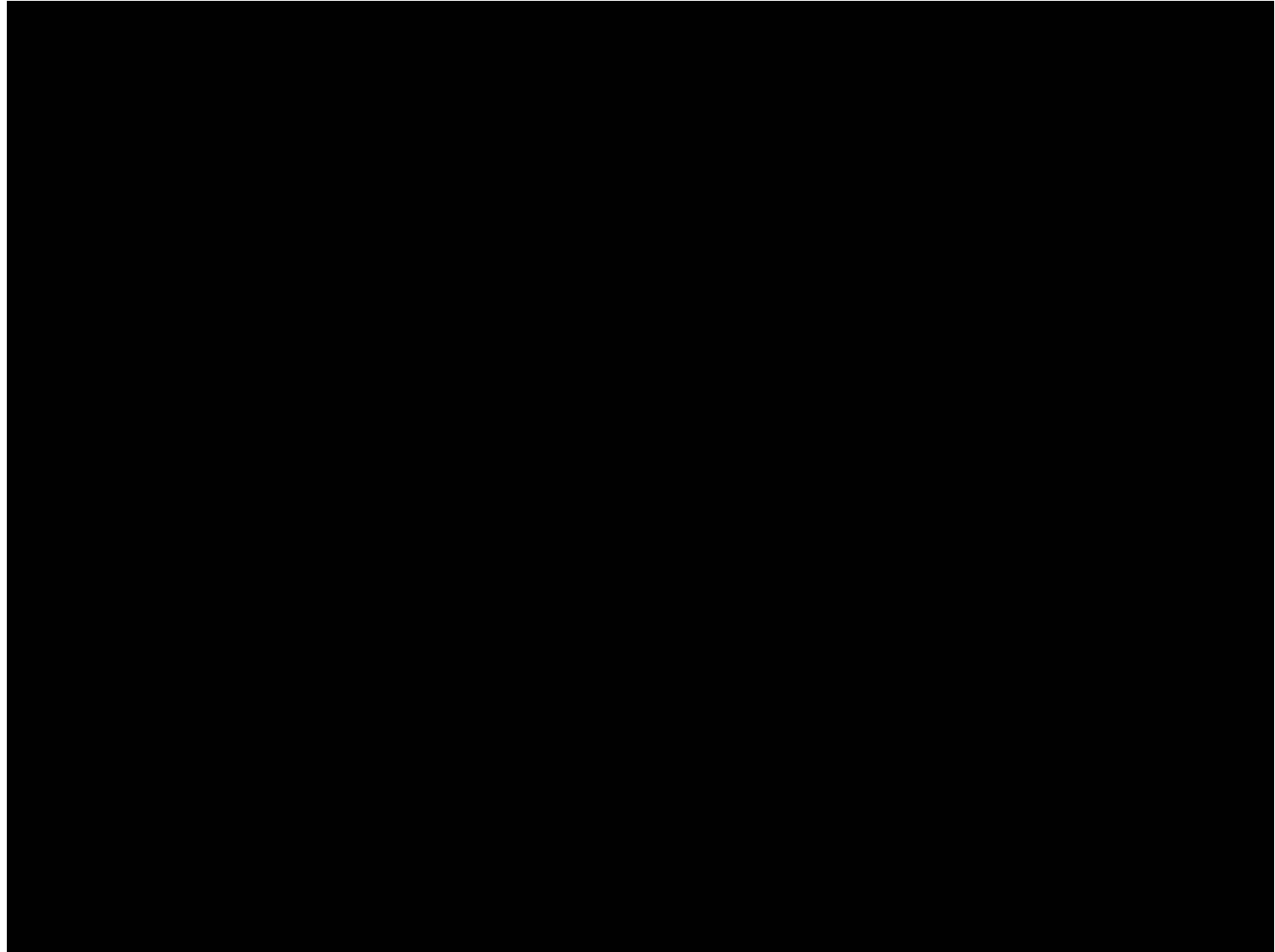

Focus and Count the Passes

We often don't want to consider our blind spots

What are the Moon Walking bears we might not be noticing because of being focused on certain aspects of a problem?



label and list 3 moon walking bears

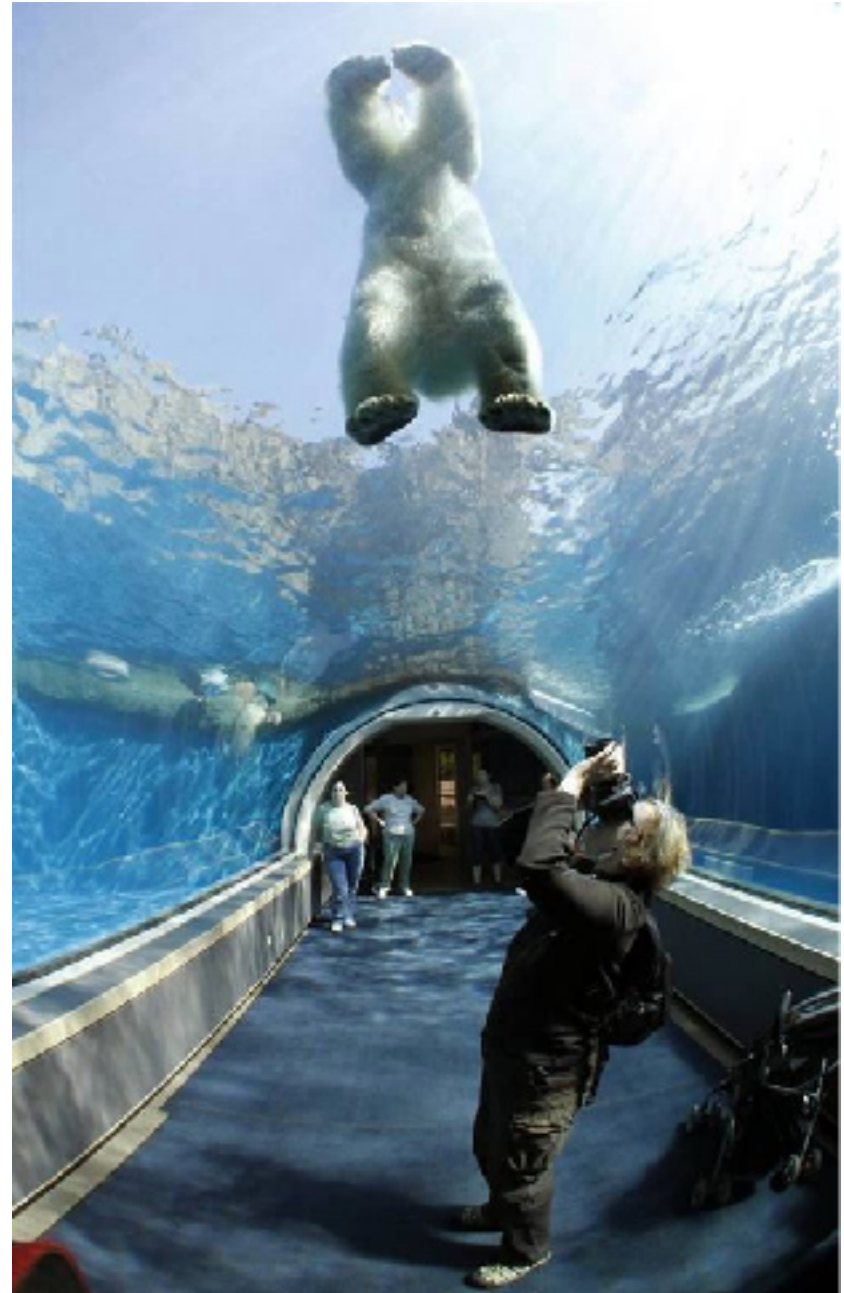

At this point You could do this... if you wanted

ZIP Analysis

- **Z- Zoom**- What could be magnified and explored more
- **I - Innovation**- Innovation opportunities or point to intervene to improve system
- **P- Potential** or Problem area
 - You spot tricky areas to navigate

Bring your skills into the system

Bring back your complexity problem solving strengths. Together see how each others skills could help with different features, and agents in the complex problem landscape.

- 📁 - Place your models in relation to the challenges
- 📁 - Draw links and connections



Simple Guiding Principles

One medium sized sticky note
Summary per table of

- 4 Guiding Principles that your team feels will help in tackling your complex challenge



Dos and Don't of Lego Serious Play

Do: LEGO® SERIOUS PLAY®

Rules of Engagement



- Be open minded
- No electronics
- Be on time for transitions
- Have hard fun
- Tell your story

- Listen and Reflect
- Trust the Process
- Question the model not the person's experience



Do: Always start with Lego Serious Play skill building

People need two things for LSP

1. Know how the bricks click together and work
2. Know that our brains can make connections, metaphors, analogies and stories from the bricks



Do: Get people to sticky note and label key features

- Lego Serious Play models can be incoherent to others looking at models later
- Labeling parts can help with coherence



Do: Short videos of teams describing their models

- At the end of a shared build get teams to share their model and have someone video the share back
- Share the videos in reports afterwards



Do: If prototyping in 3d with Lego you have to label to increase coherence

Prototype coherence

1. Is the prototype coherent?
2. Is the prototype likely to be effective in trying to do what we're trying to do?
3. Is it likely to be feasible?
4. Is it likely to be viable? operating in a policy, culture, resources
5. Is it ultimately testable?

*To be honest...
Most prototypes in lego
really suck when people
try to share them with
others who were not
part of the process*

Don't: Don't start with larger system build until you first begin with a personal perspective build

- Example- Do a strengths build or super power build around a challenge first



Option builds

4 mins

Innovation Death Star

Build a model of all the things we would have to do to ensure we don't improve and get better as an organization.

A model of things that kill innovation and kill collaboration



One Note Summary/table

What do you want to see more of?



3 mins

Build a model of a thing, an experience, a place, or an activity in your community that your group would like to see more of in your community

Association Client Persona

Together at your table create a model of a typical association member that uses your association's services.

Create some story details- **Some demographics - Needs:** What do they usually ask for? Build details of **their expertise, hopes, frustrations. Give the person a pretend name.**

Base the persona on...

- Experiences you're aware of
- Stories you've heard
- Common struggles, wishes, hopes
- It's fictional but based in experiences

Place some sticky notes with descriptors, quotes, sayings, asks.



Now Empathy Mapping

*Your Last Model placed in centre of Empathy Map
Pizza*

3 "i"

After Mapping, Tag 3 areas with
"i" where your team sees an
innovation/intervention
opportunity to improve the
situation

3 "t"

After Mapping, Tag 3 areas with
a "t" where your team sees the
top "tricky" to navigate situations
are





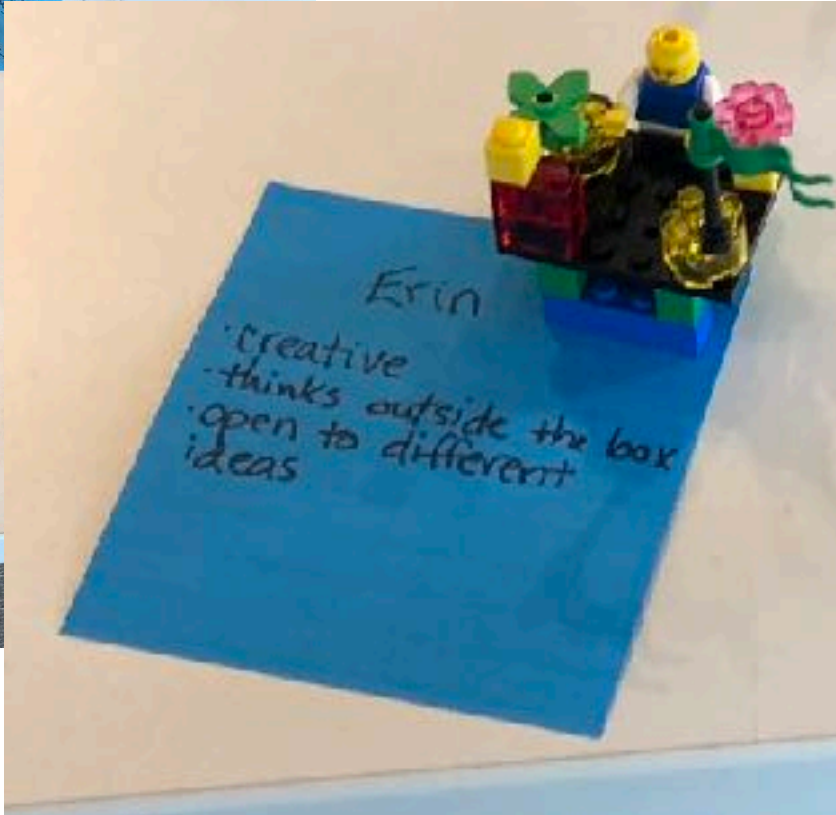

Gallery of Strengths Option



Diverse perspectives make for creative ideas

Start your story

Make assumptions
Ask questions

Go forth and think through your hands



www.thinkjarcollective.com

@thinkjar_

bweinlick@gmail.com



***THANK
YOU!***